



User Instructions

TABS® Mobility Monitor

Models 25222 and 25223



⚠ WARNING

Before installing this system, please read and follow these instructions carefully. Failure to do so could result in injury or death to a person in your care. No device is a substitute for proper nursing care.



ETL Listed 3064149
Conforms to UL1069
Certified to CSA STD C22.2 NO.205

STANLEY

**Senior
Technologies™**

0163-392-D

Contact us

Thank you for purchasing your TABS® system. If you have questions about your TABS® monitoring system or would like to speak to TABS® Customer Service, contact your local dealer, or call:

TABS® Mobility Monitors: 800-824-2996

FCC ID: HCQ 3B6UMXF Canada: 2309 101 597

This device complies with Part 15 of the FCC rules. Operation is subject to the following two conditions: 1) this device may not cause harmful interference, and 2) this device must accept any interference received, including interference that may cause undesired operation.

Changes or modifications not expressly approved by the party responsible for FCC compliance could void the user's authority to operate the equipment.

For Canadian customers: "This digital apparatus does not exceed the class A limit for radio noise emissions from digital apparatus as set out in the interference causing equipment standard entitled "Digital Apparatus" "ICES-003 of Industry Canada".

All content herein is the property of The Stanley Works, its Affiliates, or their content suppliers and is protected by United States and international copyright laws. The compilation of all content is likewise the exclusive property of The Stanley Works (or the Affiliate identified in any copyright notice) and is protected by United States and international copyright laws.

The trademarks, service marks and logos (the 'Trademarks') used and displayed in this publication are registered and unregistered Trademarks of The Stanley Works, its Affiliates and others. Nothing herein should be construed as granting, by implication, estoppel or otherwise, any license or right to use any Trademark displayed herein without the prior consent of the Trademark owner. ARIAL, AUTISM ALLY, AUTISM ALLY design, the CATCH-ALL design, SENIOR TECHNOLOGIES, TABS, TIM, WANDERGUARD, and the WANDERGUARD design are some of the registered and unregistered trademarks owned by Stanley Logistics, Inc. and/or its Affiliates ("Stanley Trademarks"). Stanley Trademarks may not be used in connection with any product or service that is not manufactured by or under license from The Stanley Works or its appropriate Affiliate.

©2007 Printed in USA

Table of Contents

Warnings and cautions	2
Check your shipment	4
How the TABS® mobility monitor works	5
Installing the wall bracket (Model 25222)	6
Installing the wire bracket (Model 25223)	9
Installing the battery	10
Alarm options	12
How the TABS® Disposable Patient Specific pressure pads work. . .	16
Troubleshooting pressure pads.	21
Nurse Call interface.	22
Replacement parts and accessories.	23
TABS® standard limited warranty	24
Daily checklist for TABS® pressure pads	25

WARNING

Read and follow these Installation instructions, particularly the warnings and cautions, before using your TABS® mobility monitor. Failure to do so may result in injury or death to a person in your care.

Test your TABS® monitor for proper operation before each use and:

- inspect the Dual Lock® fastener for any signs of wear.
- listen to the voice message to make sure it is understandable and appropriate.
- replace any components with signs of wear or damage immediately.
- make sure nurse call interface cord is securely in place.
- make sure the monitor is held securely to the wall or wheelchair bracket

Use your monitor in conjunction with your facility's fall management program. TABS® monitors are not a substitute for proper nursing care. The effectiveness of the TABS® system relies entirely on an immediate response by the caregiver to the TABS® alarm.

The TABS® mobility monitor will not stop a person from leaving a bed, chair, wheelchair or room. It is intended only to alert a caregiver that a person may need assistance. Other interventions may still be required for some people.

The TABS® mobility monitor and TABS® Disposable Patient-Specific pressure pads can be defeated by a cognitively aware person, a person with only a few moments of lucidity or an uncooperative person. Properly assess each individual before the TABS® mobility monitor is used.

Visual monitoring by caregivers is required. TABS® Disposable Patient-Specific pressure pads may not be suitable for all high risk persons; restraints may be required for some people.

A 9V alkaline battery must always be installed for proper operation of the TABS® monitoring system. The battery must be installed for the low battery alert to sound when the battery is low and to act as a battery back-up in the event of power loss on the TABS® monitor.

An intermittent "chirp" indicates a low battery. Replace the battery immediately. Use only 9V alkaline batteries. The TABS® monitor does not recharge batteries.

Resident weight may affect proper operation. TABS® pressure pad models 26000, 26100, 26120, 26550, and 26560 are not recommended for persons weighing less than 60 lbs. Models 26500 and 26501 below mattress pads are not recommended for persons weighing less than 100lbs.

Test your pressure pads and TABS® monitor before each use. Make sure your TABS® mobility monitor is working properly. Do not use the 14-day Disposable Patient-Specific pad for more than 14 days. If the pressure pads are no longer working discard them immediately.

Be certain that your protocols direct staff to log the 14-day 'Date Put In Use' date in the blank provided on the pad itself AND in the resident's chart. If the pad is used on more than one resident, the original 'Date Put In Use' date must be transferred from chart to chart.

If the cord is unplugged from the monitor and the alarm options have been set to nurse call only, the TABS® monitor reverts to a local alarm. The nurse call interface cord must be plugged into the nurse call system at all times.

 **CAUTION**

Use care when connecting or disconnecting the TABS® monitor to the nurse call system. Gently remove or connect plugs. Pulling on the cord may damage it and result in system failure.

Connect only pressure pads to the jack on the right and connect only nurse call interface cords to the jack on the left on the bottom of the monitor. An alarm will sound if either item is connected to the incorrect jack. Failure to connect a pressure pad or a nurse call cord to the proper jack will cause improper operation of the monitor.

The TABS® Disposable Patient-Specific pressure pads are designed to withstand normal wear and tear for a period of 14-days. Beyond this time, the pad may fail and fail without warning due to prolonged use and other factors, e.g. bending, exposure to moisture, punctures, repeated cord pulls, connector damage, etc.

Do not immerse in liquid or use the pad if it has been immersed in liquid. Discard the pad immediately if exposed to liquids.

Keep the pressure pads flat at all times. If the pressure pad is folded it may not function properly. Do not use the pressure pad if it has been folded.

TABS® Disposable Patient-Specific pressure pads are designed for use with TABS® monitors only. Do not substitute any other fall monitoring devices.

Do not open the TABS® case for any reason, or remove the four screws that hold the case together. The case is sealed and if the seal is broken, the warranty will be voided.

Use only the Dual Lock® fastener or screws that came with your shipment to mount the monitor brackets. Non-conforming fasteners may hinder the device's effectiveness.

Use only the power supply that is shipped with the monitor by Stanley-Senior Technologies. Failure to do so may cause improper operation or damage to the TABS® monitor.

Do not use modular T-connectors. If modular T-connectors are used, the device will not operate properly.

Check your shipment

You should have:

- One TABS® mobility monitor
- One 9V battery
- Four #4 x 1" long sheet metal screws
- Four #4-8 plastic wall anchors
- One 2" x 2½" piece of Dual Lock® fastener

Model # 25222 includes the following:

- One wall bracket

Model # 25223 includes the following:

- One wire bracket

Optional items:

- Nurse call interface cord
- TABS® pressure pads
- 12VDC power supply
- Wheelchair bracket



TABS
mobility monitor

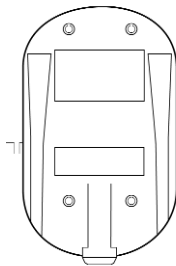

Wall mount bracket
(Model 25222)

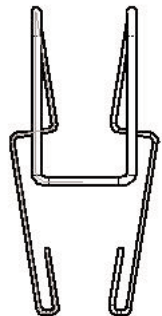

Wire bracket
(Model 25223)

How the TABS® mobility monitor works (Models 25222 and 25223)

Your TABS® monitor, when used with a TABS® pad, is designed to help reduce the risk of falls by alerting caregivers when a patient or resident is leaving a bed, chair, or wheelchair. Operation is simple. Mount the monitor on a wall using the wall bracket or on a headboard using the bed bracket. When the resident's weight is removed from the pressure pad the alarm will sound. To reset the monitor press the **RESET** button or position the patient back on the pad. (Because TABS® products are used in both hospitals and long term care settings, the terms "patient" and "resident" will be used interchangeably throughout the manual.)



The TABS® monitor has four distinct alarm tones. In addition, you can opt to have the alarm be silent at the bed, as long as the TABS® unit is connected to your facility's nurse call system. Alarm options are determined by the position of rocker switches in the battery compartment. The monitor also has audio recording capability. Finally, the TABS® monitor is designed for dual monitoring, i.e. you can use a pressure pad and a nurse call cord at the same time.

Low battery alert

The TABS® monitor is equipped with a "low battery alert" (an intermittent chirping sound) which reminds you to replace the battery immediately. Listen for the alert each time you use or test your monitor. If you hear the low battery alert, replace the battery immediately.

The TABS® monitor must have a functional 9v **alkaline** battery to operate. A plug-in power supply can be used to extend the life of the battery. The low battery alert will sound when a weak 9V battery is installed or when no battery is installed even when the plug-in power supply is used. The TABS® monitor will not function without a functional 9V **alkaline** battery installed.

Installing the wall bracket (Model 25222)

TABS® monitors should be mounted on a surface that is smooth and flat. The TABS® wall bracket can be mounted with screws or with Dual Lock® fastener. Choose the method that is appropriate for your particular environment. See *"A word about Dual Lock® fastener."*

Mounting the bracket with screws:

You will need:

- level
- pencil
- drill with $\frac{3}{16}$ " bit
- hammer
- Phillips screwdriver

1. Use the level to position the bracket straight on the mounting surface. Be sure to leave enough room above the bracket for removal of the monitor.
2. Use the bracket as a template and pencil in the screw hole positions.
3. Drill the anchor holes with a $\frac{3}{16}$ " bit.
4. Hammer in the plastic wall anchors until they are flush with the mounting surface.
5. Align the holes in the bracket to the holes you have drilled and attach the bracket using four of the 4 x 1" screws.

Mounting the bracket with Dual Lock® fastener

1. Clean the surface with rubbing alcohol and clean rag. Let it dry thoroughly before beginning your installation. Use the level to position the bracket straight on the mounting surface. Be sure to leave enough room above the bracket for removal of the monitor
2. Peel off the film on the back of the $2\frac{1}{2}$ " piece of Dual Lock® fastener. Press the fastener firmly to the wall.
3. Line up the piece of Dual Lock® fastener on the headboard with the two pieces on the bracket (Figure 1). Fasten them together by firmly pressing. You will hear a "click" when the Dual Lock® fastener is properly mounted.

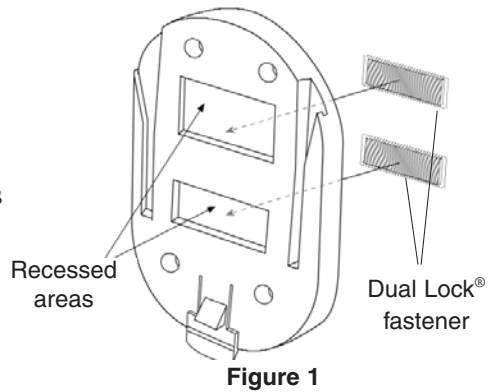

A word about Dual Lock® fastener

According to the manufacturer, if Dual Lock® fastener is used properly it can withstand up to 1,000 closures before replacement is necessary. Inspect each piece of Dual Lock® fastener regularly and replace each piece at the first sign of wear.

A piece of film covers the adhesive on the back of each piece of Dual Lock® fastener (Figures 2 and 3). The adhesive is very strong; – it was manufactured for one mount only so never reuse a piece of Dual Lock® fastener. If you remove a piece of Dual Lock® fastener from the mounting surface or bracket, replace it with a new piece of Dual Lock® fastener.

To remove Dual Lock® fastener:

The adhesive on Dual Lock® fastener bonds well enough to the mounting surface that there is a possibility it may damage your wall when you remove it. Gently grab a corner of the fastener and ease your fingers under it. Roll the Dual Lock® fastener slowly off the mounting surface.

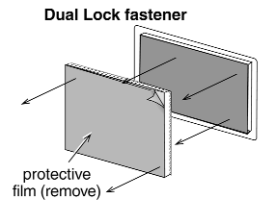

Figure 2

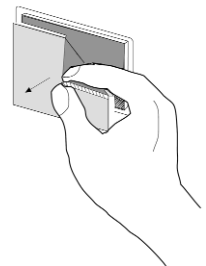

Figure 3

Inserting and removing the monitor

After the bracket has been mounted and your alarm options have been set, insert your TABS® monitor into the bracket.

1. Slide the monitor into the bracket. The rails on the back of the monitor fit into the slots on the plate. When you slide the two together, you will hear a "click" when it is properly locked into place. The front of the bracket should face the resident.
2. Check to make sure the monitor is securely in place by pulling it gently upward.

To remove the monitor

1. Gently press the release lever on the bottom of the wall bracket with one hand toward the mounting surface.
2. While pushing the release lever with one hand, slide the monitor up out of the wall bracket.

Deterring removal of the TABS® monitor from the bracket

In the event the TABS® monitor is removed from the slide lock bracket or tampered with by residents or other non-authorized persons, you may wish to make it more difficult to remove the TABS® monitor from the bracket. This can be accomplished by breaking off the lower portion of the release tab. Once the release tab has been removed, a pen or similarly shaped object carried by staff will need to be inserted into the release catch before you can slide the TABS® monitor out of the bracket.

1. If the bracket has already been installed, remove it from the wall.
2. Firmly hold the upper portion of the release tab with one hand.
3. The release tab is scored with a mark (Figure 4). Carefully position pliers along the lower side of the score mark.
4. Bend the tab backward until it breaks off (Figure 5).



Figure 4

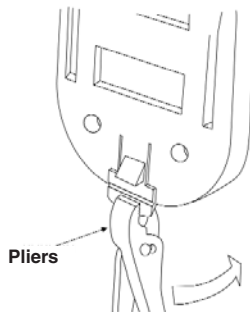

Figure 5

Installing the wire bracket (Model 25223)

To attach the bracket to the TABS® monitor, position the bracket so that one of the hooks clips over the bottom of one of the rails on the backside of the monitor. By pulling on the top end of the bracket, it will clip over the top of the rail. Do the same on the other side of the monitor. You can then place the monitor over the back of a chair. See also Figure 6.

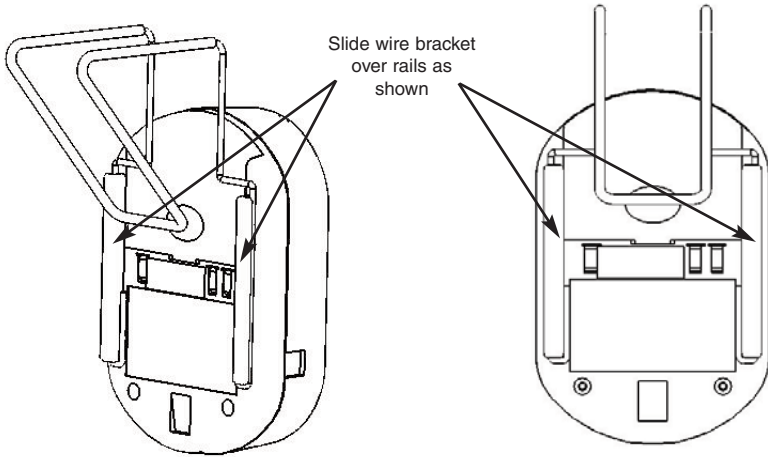

Figure 6

Wheelchair and door applications

Your TABS® mobility monitor can also be used to monitor a person in a wheelchair or to monitor an interior door. Contact your local distributor or call TABS® Customer Service at 800-824-2996 to obtain the Wheelchair Bracket Assembly, Easy-Clip Wheel Chair Bracket, or the Door Mount Kit.

Installing the battery

▲WARNING

Do not pull on the battery snap wires when installing and removing batteries. Use care when removing and installing your battery to prevent any damage to the system that may result in injury or death to the person in your care.

USE 9V ALKALINE BATTERIES ONLY when replacing batteries. Failure to do so may affect the operation of the low battery alert, which could result in injury or death to a person in your care.

DO NOT USE RECHARGEABLE BATTERIES. THE TABS® MONITOR DOES NOT RECHARGE BATTERIES.

Your TABS® monitor is shipped without the battery in place.

To insert the battery:

1. Remove the battery cover (Figure 7).
2. Lift the battery snap gently as you attach the battery to the snap.
Do not pull on the wires.
3. The battery compartment was designed to hold the battery snugly in place. Replace the battery so that the battery snap wires are out of sight on the bottom of the compartment.
4. Replace the battery cover.
5. Test the monitor by applying pressure to (for 3 seconds) and releasing pressure from the TABS® pad in the manner in which you will use it with your patient or resident. The alarm will sound. See "*Troubleshooting*" if your alarm fails to sound.

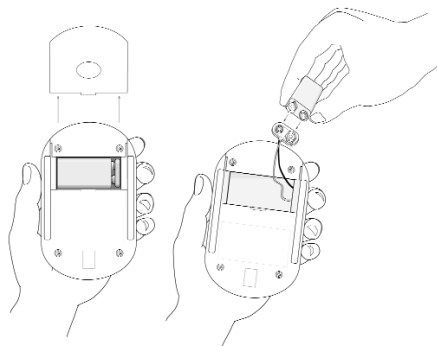

Figure 7

Connecting optional plug-in power supply

There is a red indicator light on the front of the TABS® monitor indicating power is being supplied by the plug-in power supply (Figure 8). A 9V alkaline battery needs to be installed at all times even while using the plug-in power supply. This will provide a back-up if AC power is interrupted. A low battery indicator will alarm if the battery power falls below safety requirements.

Insert plug-in power supply into power supply jack on left side of monitor (Figure 8). The red indicator light on the front of the case will be on when the monitor is connected to the plug-in power supply.

Use only the power supply that is shipped with the monitor by Stanley-Senior Technologies. Failure to do so may cause improper operation or damage to the TABS® monitor.

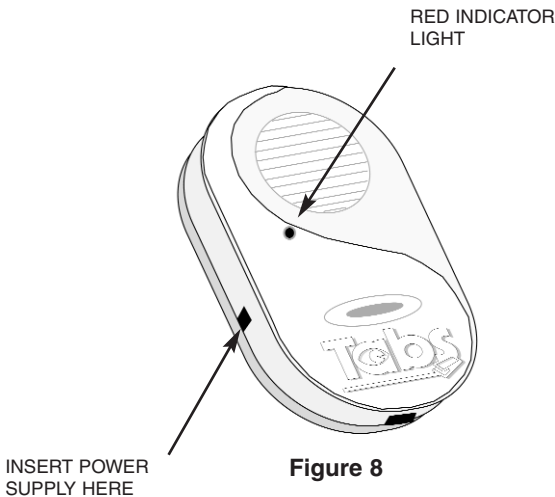

Figure 8

Alarm options

All options are set by adjusting a row of four rocker switches under the battery cover (Figure 9). To set options, remove the battery cover. Follow the diagrams below (Figure 10) for each option you select. When your options are set, replace the battery cover and test the monitor.

The position of the number 1 and number 2 switches determines the tone. The number 3 switch turns the local alarm on and off (use only with nurse call interface). The number 4 switch is for voice mode.

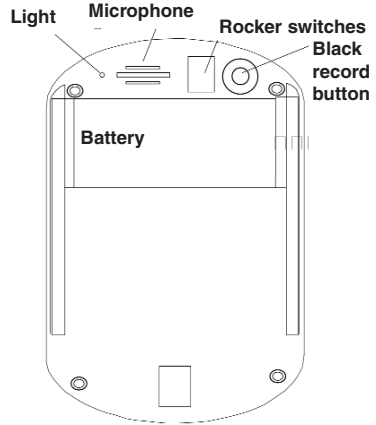

Figure 9

Use a ballpoint pen to move the switches.

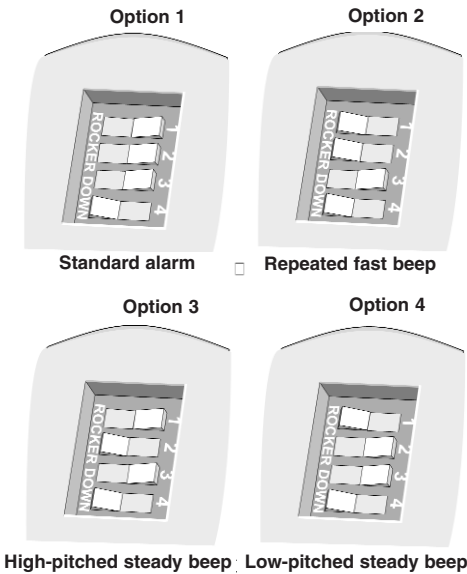

Figure 10

Local alarm on/off

▲ WARNING

If the nurse call interface cord is unplugged from the monitor and the alarm options have been set to nurse call only, the TABS® monitor reverts to a local alarm. The nurse call interface cord must be plugged into the nurse call system at all times.

Before each use and periodically during the day, check the cord to make sure it is securely in place. Failure to do so may result in injury or death to a person in your care.

If you are using the nurse call interface cord, you can set your TABS® monitor for a local alarm and nurse call alarm (Figure 11, Option A) or nurse call alarm only (Figure 11, Option B). The nurse call interface cord must be in place in the TABS® monitor to make these selections.

If the cord is detached from the monitor, the monitor will automatically revert to the local alarm mode. To set the monitor in nurse call only mode, move the number 3 rocker switch to the right position.

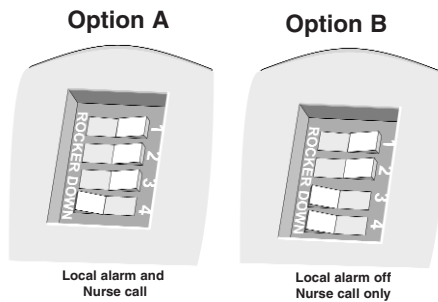

Figure 11

Voice alarm

Your TABS® monitor (Figure 12) has audio recording capability. You can record a message up to 10 seconds in length.

To record a voice message:

1. Remove the battery cover.
2. Push down the black **RECORD** button and hold it down until you are finished recording. The light will be on during this time indicating the monitor is recording (Figure 12).
3. Hold the monitor 8" - 12" from your mouth and record your message. Speak slowly and enunciate your words.
4. Replace the battery cover.
5. When you have finished recording, review your message by applying pressure (for 3 seconds) to, then releasing pressure from the TABS® pad in the manner in which you will use it with your patient or resident. Your message should be easily understood and heard. If it is not, re-record by following Steps 1 through 3.

Note: By rapidly removing and re-applying pressure to chair or bed pads while connected to the TABS® mobility monitors model #25222 or 25223, may cause the monitor to bypass the voice alert and go directly to sounding the audible alarm.

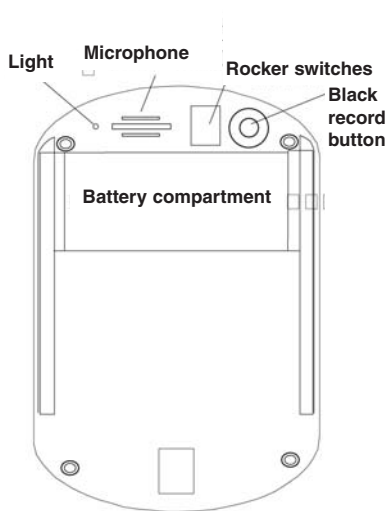

Figure 12

Voice options (Figure 13)

- To silence the local alarm without voice message, push switches 3 & 4 to the right. The nurse call cord **must be** connected (**Option A**).
- For local alarm without voice message, push switch 3 to the left and switch 4 to the right (**Option B**).
- For local alarm with voice message, move both switches 3 and 4 to the left (**Option C**).
- If you want the voice message to repeat itself, move the number 3 rocker switch to the right and the number 4 rocker switch to the left (**Option D**). The nurse call cord must be connected for the message to repeat.

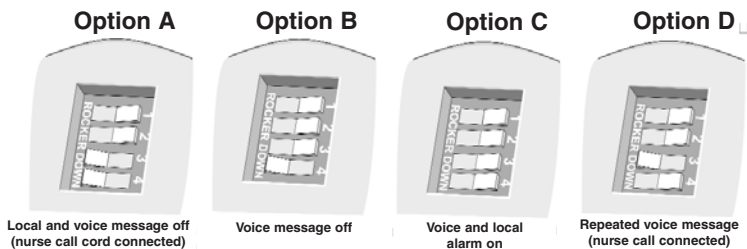

Figure 13

Testing the TABS® monitor

WARNING

Test your TABS® mobility monitor and pressure pad before each use to ensure that it is working properly. Failure to do so may result in injury or death to a person in your care.

1. Before each use, test your TABS® mobility monitor.
2. Test the system by pressing firmly on the pressure pad. The monitor will “chirp” when weight is first applied to the pad to indicate the monitor is armed. After applying constant pressure for at least 3 seconds, remove the pressure and the alarm will sound. Reset the alarm by pressing the **RESET** button on the TABS® monitor. For more instructions on how to use the pads, refer to sections “Instructions for chair pressure pad use” and “Instructions for bed pressure pad use” for your pad type.

How the TABS® 14-day Disposable Patient-Specific pressure pads work

WARNING

The TABS® Disposable Patient-Specific pressure pads were designed to withstand normal wear and tear for a period of 14 days. Do not use beyond this period. Beyond this period, the pad may fail and fail without warning due to prolonged use and other factors, e.g. bending, exposure to moisture, punctures, repeated cord pulls, connector damage, etc.

Be certain that your protocols direct staff to log the “DATE PUT IN USE” in the blank provided on the pad itself AND in the resident’s chart. If the pad is used on more than one resident, the original removal date must be transferred from chart to chart.

The TABS® monitoring system is designed to alert caregivers when someone is leaving a bed, chair or wheelchair. The TABS® Disposable Patient-Specific 14-day pad is placed on a bed, chair or wheelchair according to the instructions included with the pad. The cord is connected to the TABS® monitor. See “Alarm Options” in this manual to set the desired alarm option.

TABS® pads are designed for use with TABS® monitors only. Do not substitute any other fall monitoring devices. TABS® pads are the only pressure pads that can be used with the TABS® monitor.

The TABS® monitor is "non-latching." The alarm will stop if the resident returns to the bed or chair. The alarm is quickly and easily reset by pressing the reset button or reapplying pressure to the pressure pad.

The TABS® monitor has a built-in jack so that a pressure pad can be used along with a nurse call interface cord.

Instructions for chair pressure pad use

1. Place the pressure pad in the center of the chair seat. The side of the pressure pad with the cord on it should be at the back of the chair seat (Figure 14). Do not place the cord on top of or underneath the pressure pad.
2. Plug the TABS® pressure pad cord into the right jack on the bottom of the TABS® monitor (Figure 15). An alarm will sound if a pad is plugged into the nurse call (left) jack and weight is applied to the pad.
Note: For the timed chair pad model 26120, the timer will begin counting down when plugged into a monitor for the first time. The timer will only activate when used with models 25022, 25023, 25025, 25222, or 25223.
3. The monitor will “chirp” when weight is first applied to the pad to indicate the monitor is armed. Test the system by pressing firmly on the pressure pad for 3 seconds. When you remove the pressure, the alarm will sound. Reset the alarm by pressing the **RESET** button on the TABS® monitor.
4. Place the resident on the pressure pad. The pressure pad should be centered under the resident’s body.
5. When the resident leaves the pressure pad, the alarm will sound.
6. You can reset the alarm by pressing the reset button on the front of the monitor or by replacing the weight back on the pad.

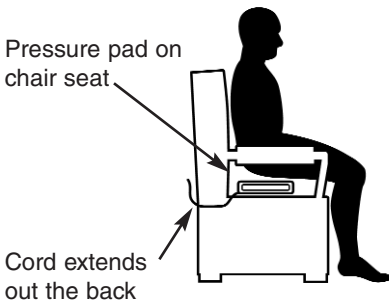

Figure 14

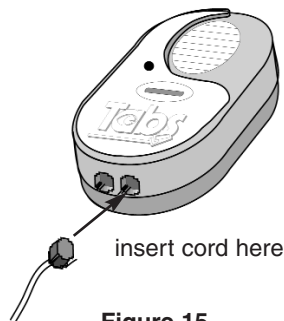

Figure 15

Instructions for bed pressure pad use

▲ WARNING

Resident weight may affect proper operation. TABS® pressure pad models 26000, 26100, 26120, 26550, and 26560 are not recommended for persons weighing less than 60 lbs. Models 26500 and 26501 below mattress pads are not recommended for persons weighing less than 100lbs.

1. The TABS® Disposable Patient-Specific pad is designed for single patient use. Once your patient has left the facility, dispose of the pad. For infection control purposes during the patient's stay, however, the pad can be disinfected with most common cleaners.
2. Place the pressure pad across the width of the mattress.
3. Position the pressure pads so that the resident's buttocks will be over the top of the pad.
4. Put the bed sheets over the top of the bed pad. *Note: Use of a mattress overlay or bed pad may affect the proper operation of the bed pressure pad. Follow test procedure found in the section "Testing the TABS® monitor."*
5. Plug the bed pressure pad cord into the right jack on the bottom of the TABS® monitor (Figure 16). An alarm will sound if a pad is plugged into the nurse call (left) jack and weight is applied to the pad.
Note: For the timed bed pad model 26560, the timer will begin counting down when plugged into a monitor for the first time. The timer will only activate when used with models 25022, 25023, 25025, 25222, or 25223.
6. Run the cord along the mattress and bed frame. Be careful not to get the cords in the way of any moving parts on the bed. Otherwise, the moving parts could sever or entangle the cord and prevent it from working.
7. Mount the TABS® mobility monitor on the headboard or wall. Refer to "Installing your TABS® monitoring system" in this manual for more detailed information on mounting the monitor. If you use the metal bracket, remember to place the TABS® monitor facing the wall, away from the patient.
8. The monitor will "chirp" when weight is first applied to the pad to indicate the monitor is armed. Test the system by pressing firmly on the pressure pad for 3 seconds. When you remove the pressure, the alarm must sound. Reset the alarm.
9. Have the resident lie normally on the mattress. The resident's body weight activates the system.
10. The alarm must sound when the resident's body weight is removed from the pressure pad.
11. You can reset the alarm by pressing the reset button on the front of the monitor or by replacing the weight back on the pad.

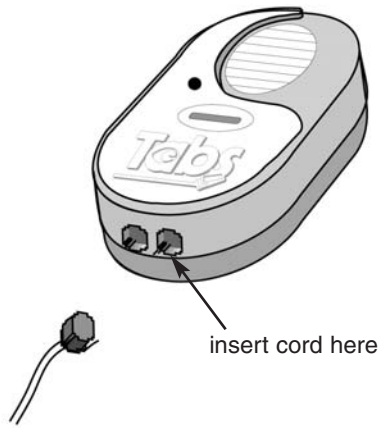

Figure 16

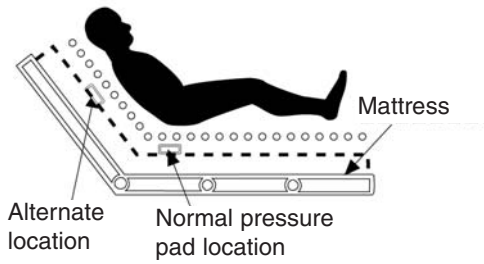

Figure 17

Testing the system

Test the TABS® monitoring system before each use and inspect the pressure pads and TABS® monitor regularly to make sure they are not damaged. Test the pressure pads by pressing firmly on the pressure pad for 3 seconds. When you remove the pressure, the alarm will sound. Reset the alarm using the reset button on the monitor or by positioning the patient back on the pad.

Maintaining the TABS® mobility monitor

- Clean soiled areas on the monitor and bracket with a damp rag and mild detergent. .
- The Dual Lock® fastener may be cleaned with most standard medical virucidal disinfectant. Spray the disinfectant on the Dual Lock® fastener and allow it to dry thoroughly. If necessary, a toothbrush may be used to gently scrub the "mushrooms."
- Inspect your TABS® monitor and all components including Dual Lock® fastener and the wall bracket regularly. If there are any signs of wear or damage, replace the component immediately. Call your TABS® Representative at 800-824-2996 if you do not already have replacement parts on hand.
- Replace the battery as soon as the low battery alert sounds.

Cleaning the pressure pad

- Clean soiled areas of cord and pressure pad with a clean cloth and water or a vinyl-tolerant solution.
- **Do not immerse pressure pad in liquid of any kind.**

Troubleshooting pressure pads

If the alarm does not sound when the resident leaves the chair or bed:

- Check the TABS® monitor. Are you using a 9V alkaline battery and has it been installed properly? Is the battery still “good”? If not, remove the battery and install a new 9V alkaline battery following the instructions in this manual.
- Check the cord. Is it connected to the TABS® monitor and is the connection secure? If not, connect the cord properly.
- Is the resident under 60 pounds? The TABS® pads are not designed for residents weighing less than 60 lbs.
- Is the resident sitting properly on the pressure pad? If not, reposition the resident or the pressure pad so that the pad is centered under the resident’s body.
- Is the pressure pad connected to the jack on the right side of the monitor. If not, reconnect the pad plug to the proper jack on the monitor.

If the alarm sounds when the resident has not left the bed or chair:

- Check to see that a fresh 9V alkaline battery is being used. If not, replace it.
- Check to see that the pressure pad cord is attached to the TABS® monitor.
- Check to see that the pressure pad is positioned correctly under the patient.

If the alarm sounds periodically:

- Check the battery. The sound you hear may be the low battery alert. Replace the battery with a 9V alkaline battery following the instructions in the “*Insert the battery*” section.

If the pressure pads still do not work, contact your local distributor, or call TABS® Sales at 800-824-2996.

Nurse call interface

CAUTION

Do not pull on the cord to remove the nurse call interface cord from either the TABS® monitor or the nurse call interface wall jack. Remove them by grasping the modular telephone plug and the jack plug heads and pulling them carefully from the TABS® monitor. Failure to do so may result in damage to the equipment.

Attach the end of the cable with the modular telephone plug to the jack on the left of the TABS® monitor (Figure 18). Insert the other end of the cable with the 1/4" jack plug into the nurse call system wall jack. If the plug does not fit the wall jack, contact your local distributor, or call TABS® Sales at 800-824-2996.

***Note:** If the nurse call interface cord is not in place, the local alarm will sound regardless of the settings. If a nurse call interface cord is mistakenly inserted in the jack on the right an alarm will sound.*

Regulations may require that a functioning nurse call system be accessible in each resident bed and bath area. A splitter may be required from your nurse call provider in order to use both TABS® and your regular call system. Please contact your local distributor, or call TABS® Sales at 800-824-2996 if you need assistance.

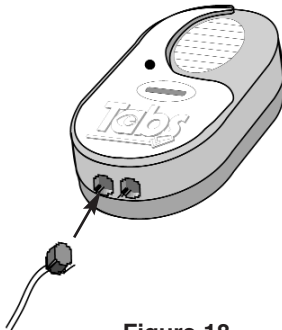

Figure 18

Replacement parts and accessories**Model/Part #**

TABS® monitor (with wire bracket)	25223
TABS® monitor (with wall bracket)	25222
Easy-Clip Wheelchair bracket	25300
Wall mount bracket	25120
Wire mount bracket	BMB-1000
Nurse call interface cord	25150
Nurse call splitter	0707-421
Door mount kit	24010
Disposable Patient-Specific chair pressure pad (14-day)	26200
Disposable Patient-Specific bed pressure pad (14-day)	26300
Dual Lock® fastener (2" x 2½")	24130
Dual Lock® fastener (2" x 1")	24131
Dual Lock® fastener 1 each: (2½" x 1" and 2" x 2½")	24132
Dual Lock® fastener (2" x ¾")	24135
12VDC plug-in power supply (U.S.)	0400-026
12VDC plug-in power supply (U.K.)	0400-066
Modular T-connector	0707-322

TABS® Warranty:

LIMITED LIFETIME WARRANTY. TABS® products are warranted to be free of defects in materials and workmanship by Stanley Security Solutions, Inc., Senior Technologies Division, (seller, hereinafter called "ST"). If any defects covered by this Warranty appear, ST will, at its option, repair or replace the defective component on an exchange basis with new or rebuilt parts at its expense, without charge for parts or labor upon delivery of such product to ST at Buyer's expense. **EXCEPTION: TABS® PADS AND ACCESSORY PRODUCTS ARE WARRANTED TO BE FREE OF MANUFACTURING DEFECTS FOR PERIODS RANGING FROM 14 DAYS TO ONE-YEAR AS SPECIFIED TO CUSTOMER.** ST is not responsible for warranty service should the TABS® product fail to be properly maintained or fail to function properly as a result of misuse, abuse, neglect, or damage caused by disasters, such as fire or lightning, damage caused by water-immersion, faulty or leaking batteries not supplied by ST, service other than by ST or units in use in violation of instructions furnished by ST. Postage, insurance, or shipping costs incurred in presenting your TABS® product for warranty service are your responsibility.

THE FOREGOING WARRANTIES ARE EXCLUSIVE AND IN SUBSTITUTION FOR, AND IN SUBMISSION FOR AND BUYER HEREBY WAIVES, RELEASES AND RENOUNCES, ALL OTHER WARRANTIES, OBLIGATIONS AND LIABILITIES OF ST AND ALL OTHER RIGHTS, CLAIMS AND REMEDIES OF BUYER AGAINST ST, EXPRESS OR IMPLIED, ARISING BY LAW OR OTHERWISE, WITH RESPECT TO ANY NONCONFORMANCE OR DEFECT IN ITEMS OR SERVICES PURCHASED HEREUNDER, INCLUDING, BUT NOT LIMITED TO: (A) ANY IMPLIED WARRANTY OF MERCHANTABILITY OR FITNESS FOR A PARTICULAR PURPOSE; (B) ANY IMPLIED WARRANTY ARISING FROM COURSE OF PERFORMANCE, COURSE OF DEALING OR USAGE OF TRADE; (C) ANY OBLIGATION, LIABILITY, RIGHT, CLAIM OR REMEDY IN TORT, WHETHER OR NOT ARISING OUT OF THE NEGLIGENCE OF SENIOR TECHNOLOGIES (WHETHER ACTIVE, PASSIVE OR IMPUTED); AND (D) ANY OBLIGATION, LIABILITY, RIGHT, CLAIM OR REMEDY FOR LOSS OF, OR DAMAGE TO, ANY EQUIPMENT.

ST SHALL HAVE NO OBLIGATION OR LIABILITY, WHETHER ARISING IN CONTRACT, TORT OR OTHERWISE, FOR LOSS OF USE, REVENUE OR PROFIT, COST OF CAPITAL, COST OF SUBSTITUTE EQUIPMENT, ADDITIONAL COSTS INCURRED BY BUYER, BUYER'S CUSTOMERS OR OTHER THIRD-PARTIES, FOR DAMAGES RESULTING FROM PERSONAL INJURY OR PROPERTY DAMAGE OR ANY OTHER INCIDENTAL OR CONSEQUENTIAL DAMAGES WITH RESPECT TO ANY NONCONFORMANCE OR DEFECT IN ANY ITEMS PROVIDED HEREUNDER.

